

ÖZELLİKLER / SPECIFICATIONS

Yer Değiştirme / Displacement	43 cm ³ /dev.
Sürekli Çalışma Basıncı / Working Pressure	190 Bar
Mak. Aralıklı Çalışma Basıncı / Max. Intermittent Pressure	250 Bar
Maksimum Azami Basınç / Max. Peak Pressure	270 Bar
Maksimum Sürekli Çalışma Devri / Max. Continuous Speed	1400 1/dak Bar
Aralıklı Maksimum Çalışma Basıncında Maksimum Devir	1800 1/dak Bar
Max. Speed At Intermit. Pressure	
Hidrolik Yağ Sıcaklığı / Oil Temperature Range	-20 & 80°C
Yağ Giriş Çapı - C / Oil Inlet Diameter - C	R 1 1/4
Yağ çıkış çapı - D / Oil Outlet Diameter - D	R 1"
Ağırlık / Weight	17 kg

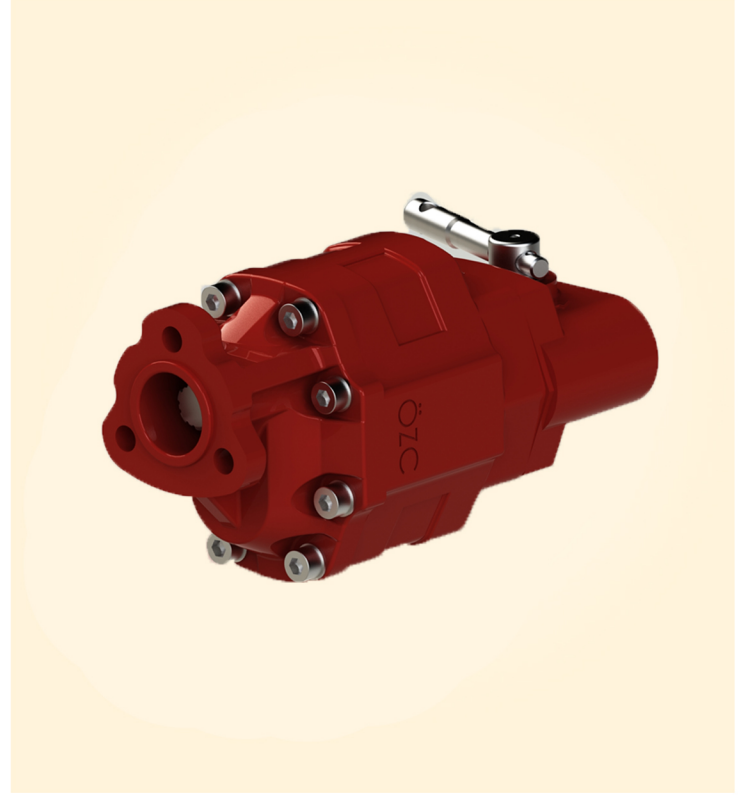

TEKNİK ÇİZİM / TECHNICAL DRAWING

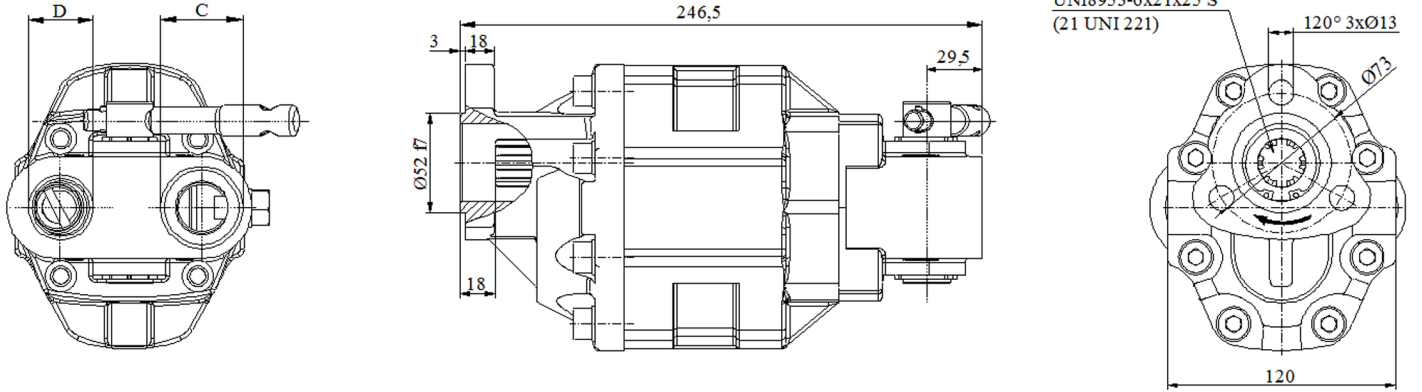

BASINÇ DEĞERLERİ / PRESSURE DEFINITION

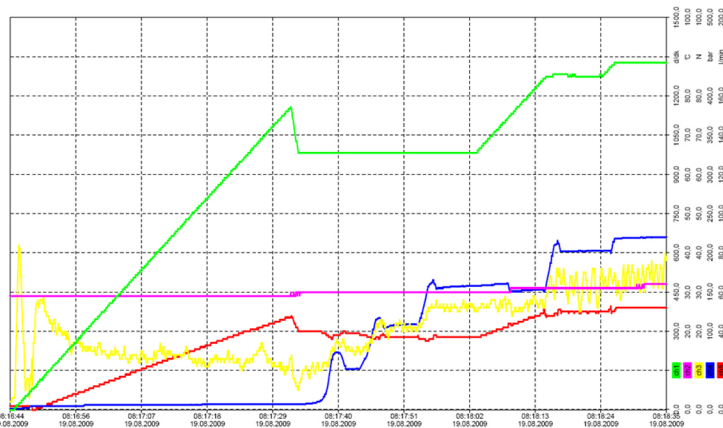

POMPA PERFORMANS GRAFİĞİ / PERFORMANCE GRAPH

