

ÖNDEN KALDIRMA TELESKOPIK SİLİNDİR

FRONT TYPE TELESCOPIC CYLINDER

www.ozceylanlar.com.tr

FCB/4500/1190/4

2215316045004



ÖZELLİKLER / SPECIFICATIONS

Maksimum Çalışma Basıncı / Maximum Working Pressure	190 bar
Toplam Yağ Hacmi / Total Oil Volume	69 lt
Silindir Ağırlığı / Cylinder Weight	241 kg
1. Kademe Maksimum İtme Kuvveti (180 bar)	39 ton
Maximum Thrust First Stage (180 bar)	
Toplam Strok / Total Stroke	4330 mm
Yağ Giriş Çapı / Oil Inlet Diameter	R 3/4"
Hidrolik Yağ Sıcaklığı / Oil Temperature Range	-20 & 80 °C
Kapalı Boy / Closed Length	1467 mm
Açık Boy / Open Length	5797 mm

KADEME TABLOSU / REFERENCES

Kademe / Extension	1	2	3	4	5	6	7
Çap / Diameter	160	135	115	95			

TEKNİK ÇİZİM / TECHNICAL DRAWING

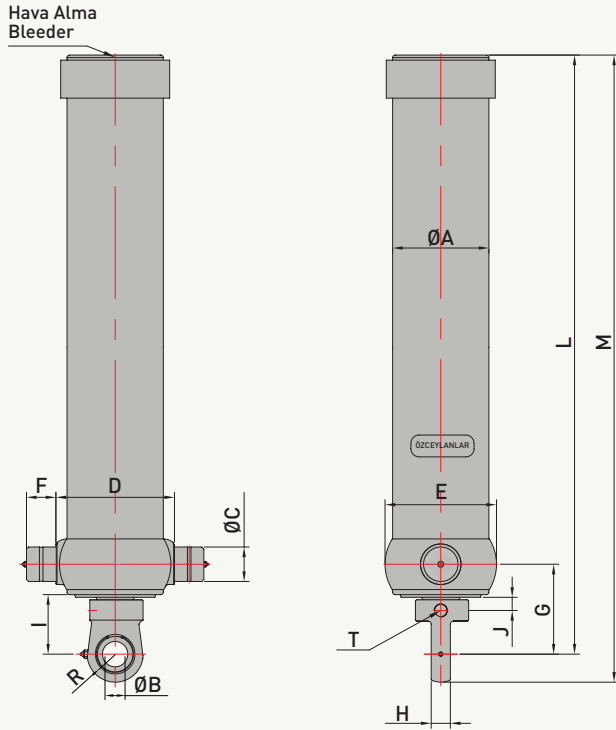

REFERANSLAR / REFERENCES

A	:	190 mm
B	:	50 mm
C	:	68 mm
D	:	234 mm
E	:	230 mm
F	:	58 mm
G	:	187 mm
H	:	40 mm
I	:	122 mm
J	:	32 mm
K	:	
L	:	1467 mm
M	:	1522 mm
N	:	
O	:	
P	:	
R	:	55 mm
S	:	
T	:	R 3/4"

KARŞILAŞTIRMA TABLOSU / COMPARISON TABLE

Strok CT 4330 mm	Kalkma Açısı α° / Body Tilting Angle α°				
	40	45	50	55	60
Bağlantı Mesafesi / Pivot Length DP (mm)	6330	5657	5123	4689	4330

