

# ÖNDEN KALDIRMA TELESKOPIK SİLİNDİR

## FRONT TYPE TELESCOPIC CYLINDER

www.ozceylanlar.com.tr

FET/5700/1190/5

2215516057005



### ÖZELLİKLER / SPECIFICATIONS

Maksimum Çalışma Basıncı / Maximum Working Pressure	190 bar
Toplam Yağ Hacmi / Total Oil Volume	74 lt
Silindir Ağırlığı / Cylinder Weight	339 kg
1. Kademe Maksimum İtme Kuvveti (180 bar) Maximum Thrust First Stage (180 bar)	39 ton
Toplam Strok / Total Stroke	5420 mm
Yağ Giriş Çapı / Oil Inlet Diameter	R 3/4"
Hidrolik Yağ Sıcaklığı / Oil Temperature Range	-20 & 80 °C
Kapalı Boy / Closed Length	1372 mm
Açık Boy / Open Length	6792 mm

### KADEME TABLOSU / REFERENCES

Kademe / Extension	1	2	3	4	5	6	7
Çap / Diameter	160	135	115	95	75		

### TEKNİK ÇİZİM / TECHNICAL DRAWING

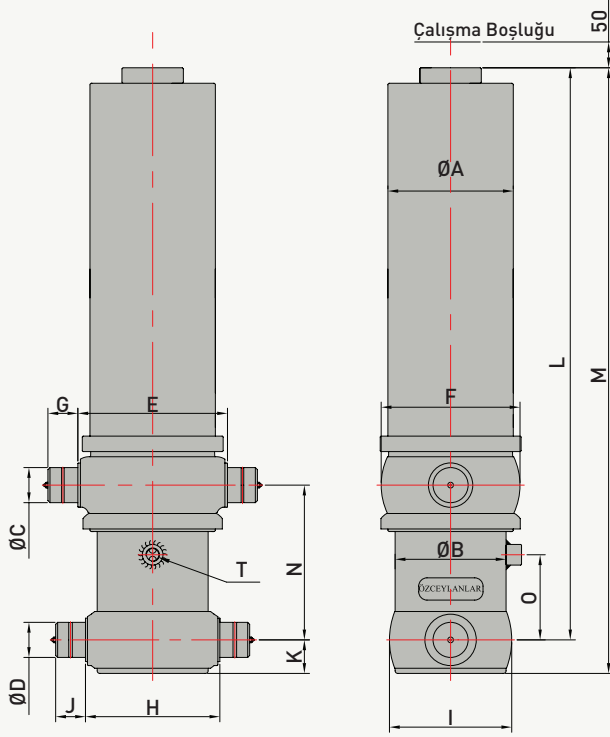

### REFERANSLAR / REFERENCES

A	:	215 mm
B	:	190 mm
C	:	68 mm
D	:	68 mm
E	:	260 mm
F	:	255 mm
G	:	58 mm
H	:	234 mm
I	:	230 mm
J	:	58 mm
K	:	65 mm
L	:	1372 mm
M	:	1437 mm
N	:	300 mm
O	:	165 mm
P	:	
R	:	
S	:	
T	:	R 3/4"

### KARŞILAŞTIRMA TABLOSU / COMPARISON TABLE

Strok CT 5420 mm	Kalkma Açısı $\alpha^{\circ}$ / Body Tilting Angle $\alpha^{\circ}$				
	40	45	50	55	60
Bağlantı Mesafesi / Pivot Length DP (mm)	7924	7082	6412	5869	5420

