

ÖNDEN KALDIRMA TELESKOPIK SİLİNDİR

FRONT TYPE TELESCOPIC CYLINDER

www.ozceylanlar.com.tr

FE/3500/1165/3

2215113535003



ÖZELLİKLER / SPECIFICATIONS

Maksimum Çalışma Basıncı / Maximum Working Pressure	190 bar
Toplam Yağ Hacmi / Total Oil Volume	45 lt
Silindir Ağırlığı / Cylinder Weight	176 kg
1. Kademe Maksimum İtme Kuvveti (180 bar)	28 ton
Maximum Thrust First Stage (180 bar)	
Toplam Strok / Total Stroke	3270 mm
Yağ Giriş Çapı / Oil Inlet Diameter	R 3/4"
Hidrolik Yağ Sıcaklığı / Oil Temperature Range	-20 & 80 °C
Kapalı Boy / Closed Length	1380 mm
Açık Boy / Open Length	4650 mm

KADEME TABLOSU / REFERENCES

Kademe / Extension	1	2	3	4	5	6	7
Çap / Diameter	135	115	95				

TEKNİK ÇİZİM / TECHNICAL DRAWING

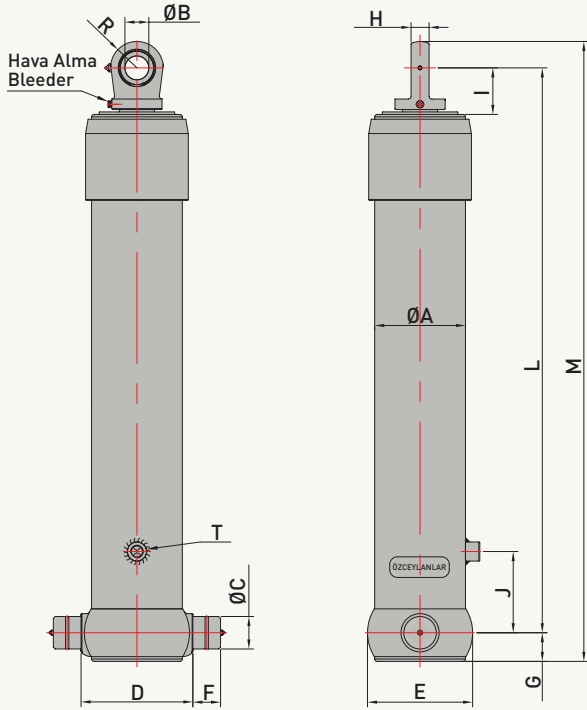

REFERANSLAR / REFERENCES

A	:	165 mm
B	:	50 mm
C	:	65 mm
D	:	204 mm
E	:	195 mm
F	:	58 mm
G	:	65 mm
H	:	40 mm
I	:	100 mm
J	:	165 mm
K	:	
L	:	1380 mm
M	:	1500 mm
N	:	
O	:	
P	:	
R	:	55 mm
S	:	
T	:	R 3/4"

KARŞILAŞTIRMA TABLOSU / COMPARISON TABLE

Strok CT 3270 mm	Kalkma Açısı α° / Body Tilting Angle α°				
	40	45	50	55	60
Bağlantı Mesafesi / Pivot Length DP (mm)	4780	4272	3869	3541	3270

